



XMASTER®

CONTENTS

00 P00-02

Operating Center
About XMASTER
Factory Show

01 P03-17

Weight Plates
Rubber Competition Bumper Plate
Competition Change Plate
Rubber Training Bumper Plate
Urethane Bumper Plate
Powerlifting Plate
Technique Plate

02 P18-22

Barbells
Competition Weightlifting Barbell
Multi-function Training Barbell
Powerlifting Barbell
1.38m Barbell
Dumbbell Bar

03 P23-29

Dumbbells
Urethane Dumbbell
Fixed Chromed Steel Dumbbell
Fixed Weight Straight Barbell
Fixed Weight Curl Barbell
Urethane Dumbbell Bumper

04 P30-38

Rack
Half Rack
Full Rack
Functional Training Rack
Rack Attachments

05 P39-41

Bench
Flat Bench
Adjustable Bench

06 P42-44

Storage
Dumbbell Rack
Fixed Weight Barbell Rack
Vertical Plate Tree

07 P45-65

Conditioning
Strength Training
Heavy Mug
Protection Gear
Speed Rope
Rubber Floor



OPERATING CENTER

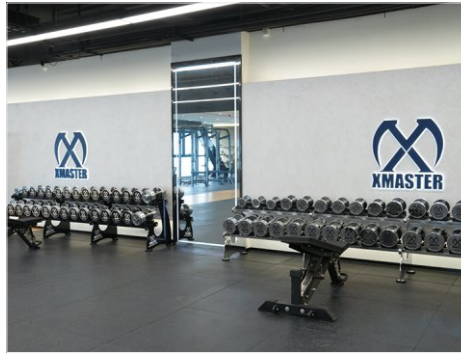

COMPANY PROFILE



XMASTER Fitness have been specialized in strength training equipment and accessories for more than 10 years. Our main products including the weightlifting bumpers, powerlifting, barbells, dumbbells, kettlebells, fitness racks , workout benches etc.

XMASTER Fitness exists to provide a refreshing and fun community in the fitness space with innovative and top quality fitness equipment at affordable prices.

We hold ourselves to excellence, innovation & reliability as we strive to continuously to design & produce the highest quality fitness equipment for physical improvement, performance & enjoyment to help our customers engage, evolve & thrive.

XMASTER Fitness sincerely invite worldwide trades and friends to visit our factory and seek for the chance for cooperation.

FACTORY SHOW



Rubber Competition Bumper Plate



Size: 5KG/10KG/15KG/20KG/25KG

Thickness: 25 /35 /48 /59 /75mm

Color: White /Green /Yellow /Blue /Red

Diameter: 450mm

Collar Opening: 50.4 ± 0.1 mm

Weight Tolerance: ± 10 g



1. IWF Standard
2. Environmental-friendly Natural rubber.



3. Chrome coating with excellent rust prevention capability, more durable and attractive appearance.



4. Grooves texture design for non-slip.

Competition Change Plate



Size /Diameter /Thickness

0.5KG / Φ 135mm /12.5mm 1 KG / Φ 160mm /15mm

1.5KG / Φ 175mm /18mm 2 KG / Φ 190mm /19mm

2.5KG / Φ 210mm /19mm 5 KG / Φ 230mm /26mm

Color: White /Green /Yellow /Blue /Red /White

Collar Opening: 50.4 \pm 0.1mm

Weight Tolerance: \pm 10g



1. Environmental-friendly Nature rubber, odourless.



2. IWF Standard, weight tolerance \pm 10g.



3. The high-quality exterior of rubber coating for holding steady which matches with Φ 50mm barbell.

Add-on Change plate



Size	/Diameter	/Thickness
0.25KG	/Φ115mm	/10mm
0.5KG	/Φ125mm	/14mm
0.75KG	/Φ138mm	/18mm
1KG	/Φ143mm	/20.3mm
Collar Opening: 35± 0.1mm		
Weight Tolerance: ±15g		



1. Unique twistable design, durable and tear resistant.



2. Convenient and quick to be opened up at one end and used for accurate weighting for a wide range of products.



3. Flexible and lightweight, easy to carry.

Premium Color Stripe Bumper Plate



Size: 5KG/10KG/15KG/20KG/25KG

Thickness: 27 /35 /49 /59 /67.5mm

Color: White /Green /Yellow /Blue /Red

Diameter: 450mm

Collar Opening: 50.4 ±0.2mm

Weight Tolerance: ±1%



1. Environmental rubber, Color stripe design for quick weight identification, thinner design to load more weight on the barbell.



2. Stainless steel inserts for longer service life.



3. Grooves texture design for non-slip.

Premium Black Bumper Plate



Size: 5KG/10KG/15KG/20KG/25KG

Thickness: 27 /35 /49 /59 /67.5mm

Color: White

Diameter: 450mm

Collar Opening: 50.4 ±0.2mm

Weight Tolerance: ±1%



1. Environmental-friendly rubber, good abrasion resistance, white raised logo, easy to identify.



2. Stainless steel inserts for longer service life.

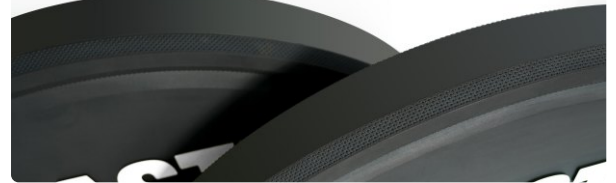

3. Grooves texture design for non-slip.

Rubber Hand Grip Plate



Size	/Diameter	/Thickness
5 KG	/Φ300mm	/25mm
10 KG	/Φ360mm	/29mm
15 KG	/Φ390mm	/35mm
20 KG	/Φ420mm	/35mm
25 KG	/Φ450mm	/37mm
Collar Opening: 50.4±0.2mm		
Weight Tolerance: ±2%		



1. Laser cutting and NC precision grind.



2. One-piece vulcanization plate, ergonomic comfortable grip, durable stainless center ring.



3. Environmental rubber, Color stripe design for quick weight identification.

Warrior Wheel Bumper Plate



Size: 30KG /35KG

Thickness: 53 /56mm

Diameter: 660mm

Collar Opening: 50.4 ± 0.2 mm

Weight Tolerance: $\pm 1\%$



1. Special heavy weight design for strong trainers.



2. Environmental-friendly natural rubber.



3. Novel grooves design for grip the plate easily.

Urethane Bumper Plate



Size: 10KG/15KG/20KG/25KG

Thickness: 35 /40 /50 /54mm

Color: Pink /Green /Yellow /Blue /Red

Diameter: 450mm

Collar Opening: 50.4 ± 0.2 mm

Weight: $\pm 1\%$



1. Environmental-friendly CPU, good abrasion resistance, more crash resistant capability.



2. Chrome coating with excellent rust prevention capability, more durable and attractive appearance.



3. Appropriate hardness, minimize the bounce on the drop for safe training.

Premium Urethane Grip Plate



Size /Diameter /Thickness
5 KG / ϕ 300mm /25mm
10 KG / ϕ 360mm /29mm
15 KG / ϕ 390mm /35mm
20 KG / ϕ 420mm /35mm
25 KG / ϕ 450mm /37mm
Color: Multicolour /Pink /Black
Collar Opening: 50.4 ± 0.2 mm
Weight: $\pm 1\%$



1.Environmental-friendly odourless CPU, good abrasion resistance, more crash resistant capability. Easy for cleaning. solid steel inside achieves a smooth plate surface, thinner design allows for loading more weight.



2.Solid steel inside achieves a smooth plate surface, thinner design allows for loading more weight.

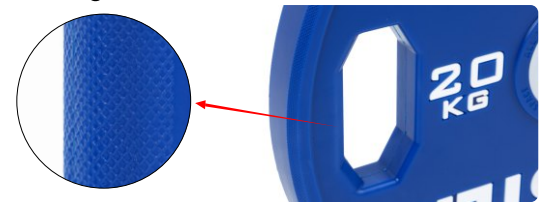

3.Unique knurling on grips for more anti-slip grip.

Stripe Chrome Steel Plate



Size	/Diameter	/Thickness		
0.25KG	/Φ112mm	/4.6mm	0.5KG	/Φ134mm /5.7mm
1.25KG	/Φ160mm	/9.7mm	2.5KG	/Φ190mm /13.2mm
5 KG	/Φ228mm	/ 18.8mm	10 KG	/Φ325mm /18mm
15 KG	/Φ400mm	/ 18mm	20 KG	/Φ450mm /19mm
25 KG	/Φ450mm	/ 22.8mm		

Stripe Color: White /Green /Yellow /Blue /Red
Collar Opening: 50.5± 0.1mm
Weight Tolerance: (10~25kg) ± 30g (0.25~5kg) ± 15g



1. Laser cutting and NC precision grind.



2. Chrome coating with excellent rust prevention capability, more durable and attractive appearance.



3. Color stripe design for quick weight identification.

Stripe Chrome Steel Plate(Gold Color)



Size	/Diameter	/Thickness		
0.25KG	/Φ112mm	/4.6mm	0.5KG	/Φ134mm /5.7mm
1.25KG	/Φ160mm	/9.7mm	2.5KG	/Φ190mm /13.2mm
5 KG	/Φ228mm	/ 18.8mm	10 KG	/Φ325mm /18mm
15 KG	/Φ400mm	/ 18mm	20 KG	/Φ450mm /19mm
25 KG	/Φ450mm	/ 22.8mm		

Stripe Color: White /Green /Yellow /Blue /Red
Collar Opening: 50.5± 0.1mm
Weight Tolerance: (10~25kg) ± 30g (0.25~5kg) ± 15g



1. Laser cutting and NC precision grind.



2. Chrome coating with excellent rust prevention capability, more durable and attractive appearance.



3. Color stripe design for quick weight identification.

Chrome Steel Plate -Pro



Size	/Diameter	/Thickness
5 KG	/Φ228mm	/18mm
10 KG	/Φ325mm	/17mm
15 KG	/Φ400mm	/17mm
20 KG	/Φ450mm	/17mm
25 KG	/Φ450mm	/21mm

Collar Opening: 50.5 ± 0.1 mm
Weight Tolerance: $\pm 1\%$
custom logo: Chrome steel end cap+ rubber raised logo underneath



1. Laser cutting and NC precision grind.



2. Chrome coating with excellent rust prevention capability, more durable and attractive appearance.



3. Novel grooves design for grip the plate easily.

Chrome Steel Hand Grip Plate



Size	/Diameter	/Thickness
10 KG	/Φ400mm	/13.5mm
15 KG	/Φ400mm	/19mm
20 KG	/Φ450mm	/20mm
25 KG	/Φ450mm	/24mm
Collar Opening: 50.4±0.2mm		
Weight Tolerance: ±1%		



1. Laser cutting and NC precision grind.



2. Chrome coating with excellent rust prevention capability, more durable and attractive appearance.



3. Color stripe design for quick weight identification.
4. Anti-slip hand grip design to grip the plate easily

Calibrated Powerlifting Plate



Size	Diameter	Thickness	Weight	Diameter	Thickness
0.25KG	Φ112mm	4.6mm	0.5KG	Φ134mm	5.7mm
1.25KG	Φ160mm	9.7mm	2.5KG	Φ190mm	13.5mm
5 KG	Φ228mm	18mm	10 KG	Φ325mm	17.4mm
15 KG	Φ400mm	17.2mm	20 KG	Φ450mm	18.1mm
25 KG	Φ450mm	22mm			

Stripe Color: White /Green /Yellow /Blue /Red
Collar Opening: 50.5± 0.1mm
Weight Tolerance: ± 20g



1. 50.5mm collar opening for a snug fit.



2. Calibration steel plugs on back of plates for a greater level precision.



3. Durable colorful powder coating for standard PL training.

Technique Plates



Size: 2.5KG/5KG

Thickness: 81/100mm

Color: /Red/White

Diameter: 450mm

Collar Opening: 50.4 ± 0.1 mm

Weight Tolerance: ± 30 g



1. Special HDPE material.



2. Design for Teenagers and beginners.



3. Hollow design with consistent tenacity on the drop.

Weightlifting Barbell



Product Name	Weight	Length	Diameter	Bearing	Sleeve Length	Max Load Weight
Competition Weightlifting	20KG	2200mm	28mm	10	415mm	1500LB
Competition Weightlifting	15KG	2010mm	25mm	10	320mm	1200LB
Multi-function Training	20KG	2200mm	28mm	8	415mm	1200LB
Multi-function Training	15KG	2010mm	25mm	8	320mm	1000LB
Powerlifting Barbell	20KG	2200mm	29mm	0	432mm	1800LB



1. Quality needle / bearings, friction-welded sleeves, non-abrasive knurl pattern.

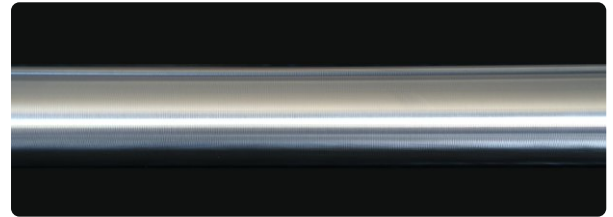

2. Precision on design and construction.

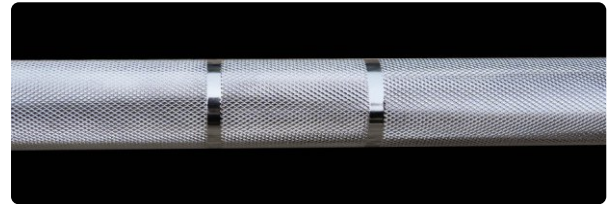

3. Excellent chrome coating for rust prevention, different knurl grade for non-slip purpose.

Competition Weightlifting

1.2mm Knurling

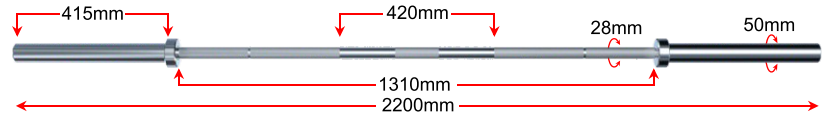
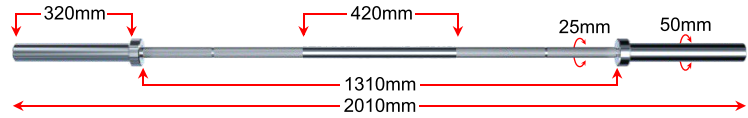

Multi-function Training

1.2mm Knurling

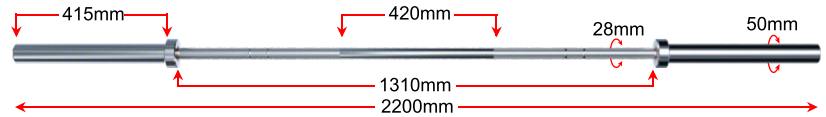
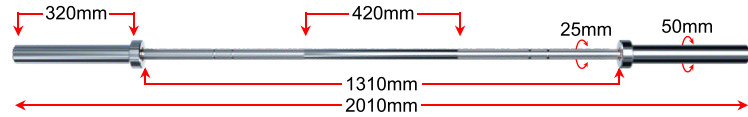

Powerlifting Barbell

1.5mm Knurling



1.38m Barbell



Product name	Weight	Length	Diameter	Sleeve length	Max loadable weight
1.38m Barbell	12.5KG	1380mm	28mm	265mm	150KG



1. The quality bronze bushing construction, friction-welded sleeves, no-abrasive knurl pattern.



2. Precision on design and construction.

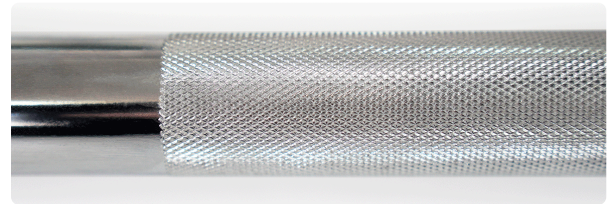

3. Excellent chrome coating for rust prevention.

1.38m Curl Barbell

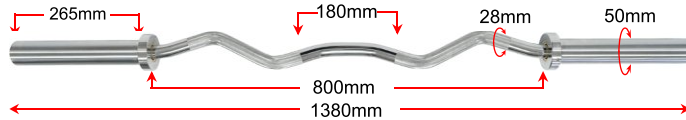

Product name	Weight	Length	Diameter	Sleeve length	Max loadable weight
1.38m Curl Barbell	12.5KG	1380mm	28mm	265mm	150KG



1. The quality bronze bushing construction, friction-welded sleeves, no-abrasive knurl pattern.



2. Precision on design and construction.

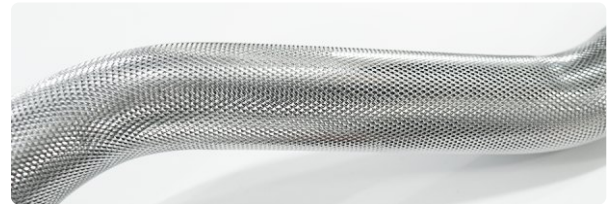

3. Excellent chrome coating for rust prevention.

Loadable Dumbbell Bar



Size: 3.5KG/5KG/7.5KG

Length: 364/435/590mm

Sleeve length: 102/133/215mm

Sleeve diameter: 50.0mm

Diameter of Handle: 28mm

Application type: rubber weight plate, strength weight plate, dumbbell plate



1. Chrome coating with excellent rust prevention capability, more durable and attractive appearance.



2. Quality bronze bushings for a smooth spin.

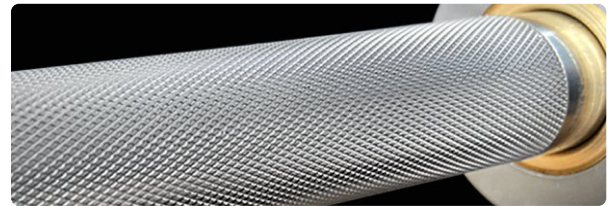

3. Non-abrasive knurl pattern.

Urethane Dumbbell



Product Name: Urethane Dumbbell
Weight Range: 2.5KG ~60KG
Weight Increase: 2.5KG increments.
Diameter: 32mm/34mm
Weight Tolerance $\pm 1\%$
Bar Coating: Chromed / Black



1.Environmental-friendly CPU, good abrasion resistance, more crash resistant capability .



2.Chrome coating dumbbell bar with excellent rust prevention capability, more durable and attractive appearance



3.Compact round design, a more centralized weight distribution for better training feel.

8-Sided Urethane Dumbbell



Product Name: 8-Sided Urethane Dumbbell
Weight Range: 2.5KG~60KG
Weight Incremental: 2.5kg per size
Diameter of Handle :20mm/32mm/34mm
Weight Tolerance : $\pm 1\%$



1. Eco-friendly odourless CPU, easy for cleaning.



2. Unique octagonal three-dimensional design with anti-slip slope design on the edge, ensure the safety and better feeling of training



3. Special textured surface with good abrasion resistance, more crash resistant capability and attractive appearance.

Fixed Chromed Steel Dumbbell



Size: 2.5KG/ 60KG

Diameter of Handle: 20mm/32mm/34mm

Weight Tolerance: $\pm 1\%$



1. Excellent chrome coating, high rust prevention capability, more durable.



2. Precision work design, a more centralized weight distribution for good feel of training.



3. Custom logo available.

Fixed Chromed Steel Dumbbell

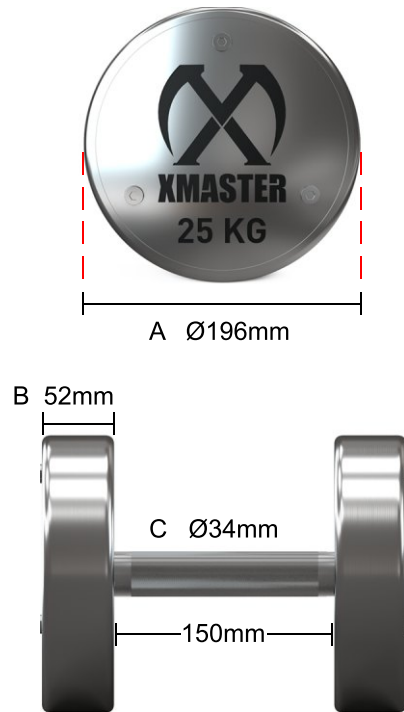

Size	A Diameter	B Plate thickness	C Diameter of Handle
2.5KG	128mm	12mm	20mm
5KG	128mm	23mm	32mm
7.5KG	156mm	23mm	32mm
10KG	156mm	32mm	32mm
12.5KG	156mm	40mm	32mm
15KG	176mm	39mm	32mm
17.5KG	176mm	45mm	32mm
20KG	176mm	52mm	32mm
22.5KG	196mm	47mm	34mm
25KG	196mm	52mm	34mm
27.5KG	196mm	57mm	34mm
30KG	196mm	63mm	34mm
32.5KG	196mm	68mm	34mm
35KG	196mm	73mm	34mm
37.5KG	196mm	79mm	34mm
40KG	196mm	84mm	34mm
42.5KG	196mm	89mm	34mm
45KG	196mm	94mm	34mm
47.5KG	196mm	100mm	34mm
50KG	196mm	105mm	34mm
52.5KG	196mm	110mm	34mm
55KG	196mm	116mm	34mm
57.5KG	196mm	121mm	34mm
60KG	196mm	126mm	34mm

Fixed Weight Straight Barbell



Size: 10KG/ 12.5KG/ 15KG/ 17.5KG/ 20KG/ 25KG/

30KG/ 35KG/ 40KG/ 45KG/ 50KG

Diameter: 156mm /176mm /196mm

Diameter of handle: 32mm

Weight Tolerance: $\pm 1\%$

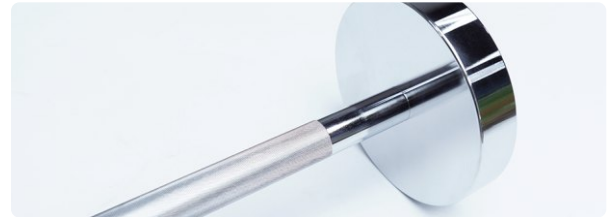

1. Excellent chrome coating, high rust prevention capability, more durable.



2. Compact design, a more centralized weight distribution for good feel of training.



3. Special design combines weightlifting and traditional dumbbells for a great feel and performance.

Fixed Weight Curl Barbell



Size: 10KG/ 12.5KG/ 15KG/ 17.5KG/ 20KG/ 25KG/
30KG/ 35KG/ 40KG/ 45KG/ 50KG
Diameter: 156mm /176mm /196mm
Diameter of handle: 32mm
Weight Tolerance: $\pm 1\%$



1. Excellent chrome coating, high rust prevention capability, more durable.

2. Compact design, a more centralized weight distribution for good feel of training.



3. Special design combines weightlifting and traditional dumbbells for a great feel and performance.

Urethane Dumbbell Bumper



Size: 5KG /7.5KG /10KG /15KG /20KG
Thickness: 29mm/37mm/46mm/64mm/81mm
Color: Black /Green /Yellow /Blue
Diameter: 230mm
Collar Opening: 50.4mm±0.2mm
Weight Tolerance: ±1%



1.Environmental-friendly CPU, good abrasion resistance, more crash resistant capability.



2.Chrome coating with excellent rust prevention capability, more durable and attractive appearance.



3.Compact design, a more centralized weight distribution to load more weight on dumbbell.

Multi Purpose Half Rack



Assembling Size: 1200x1550x2300 (L * W * H)
Steel Size: 75X75X3mm
Storage Capacity: 600KGS
Spaced at each Storage Pin: 500mm
Length of Storage Pin: 180mm

Size

Please Note: Each bench is slightly measurements error due to the manual measuring.

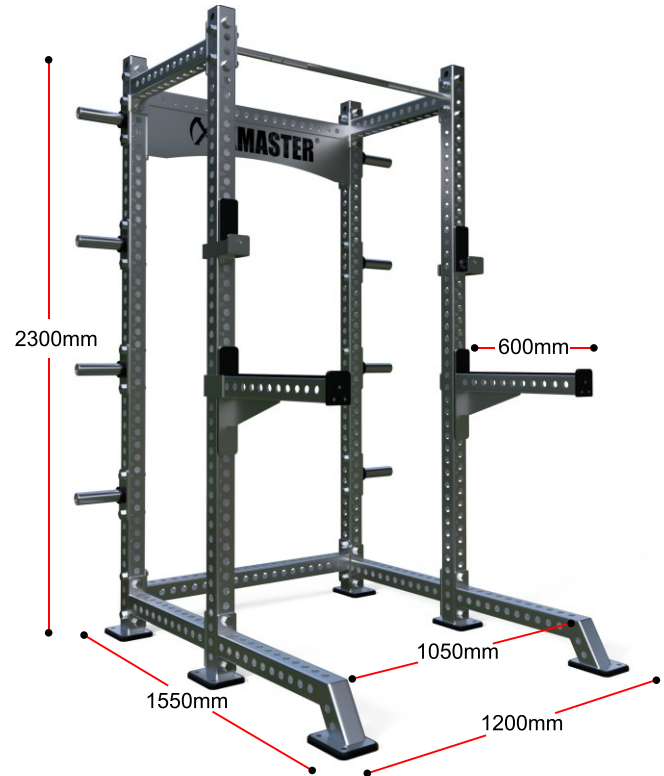

Multi Purpose Half Rack



1.Perfection positioning

A set of standard J-CUPS with XMASTER logo, adjustable space to achieve the perfection positioning for your bench press.

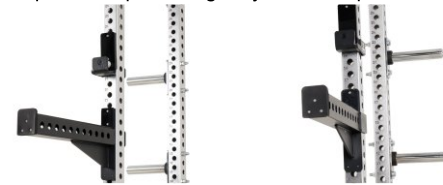

2.Positioning Holes

Eight plate posts with high space efficiency to store more plates. Adjustable holes with laser numbers for easy achieve your height options.



3.Secure ability

Heavy-duty steel rack and safety spotter arms are designed to protect both the trainer and barbell.

The Customized Solutions



Xmaster provide the customized options as your expand accessories for racks as below:

- J-CUP
- Safety-arms
- Custom Logo arch
- Uprights

Multi Purpose Full Rack



Assembling Size: 1200x1100x2300 (L * W * H)
Steel Size: 75X75X3mm
Spaced at each Storage Pin: 500mm

Size

Please Note: Each bench is slightly measurements error due to the manual measuring.

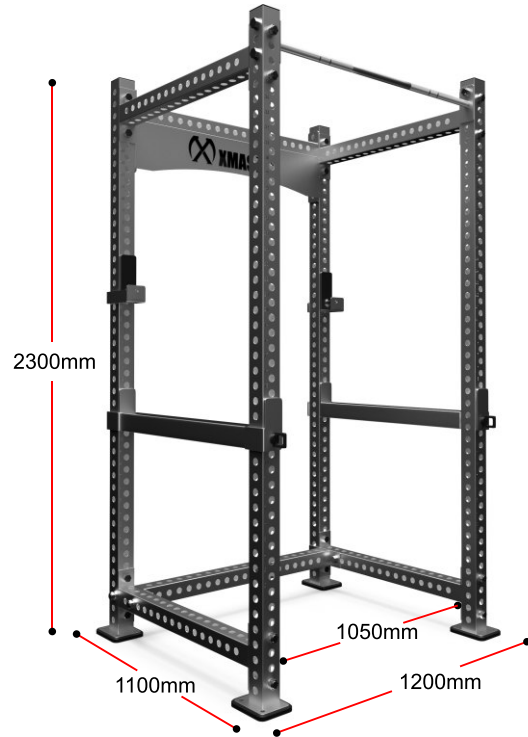

Multi Purpose Full Rack



1.Perfection positioning

A set of standard J-CUPS with XMASTER logo, adjustable space to achieve the perfection positioning for your bench press.



2.Positioning Holes

Adjustable holes with laser numbers for easy achieve your height options.



3.Secure ability

Heavy-duty steel rack and safety spotter arms are designed to protect both the trainer and barbell.

Multi Purpose Power Rack



Assembling Size: 1200x1800x2300 (L * W * H)
Steel Size: 75X75X3mm
Spaced at each Storage Pin: 500mm
Length of Storage Pin: 180mm

Size

Please Note: Each bench is slightly measurements error due to the manual measuring.



Multi Purpose Power Rack



frontage



side



1.Perfection positioning

A set of standard J-CUPS with XMASTER logo, adjustable space to achieve the perfection positioning for your bench press.



2.Positioning Holes

Adjustable holes with laser numbers for easy achieve your height options.



3.Secure ability

Heavy-duty steel rack and safety spotter arms are designed to protect both the trainer and barbell.

Functional Training Rack

Attachment: Cable Pulley Machine、Smith Machine

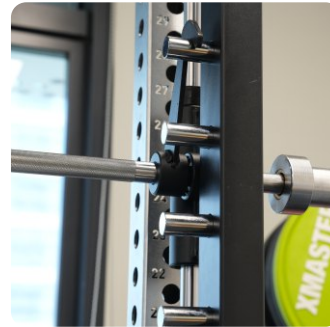
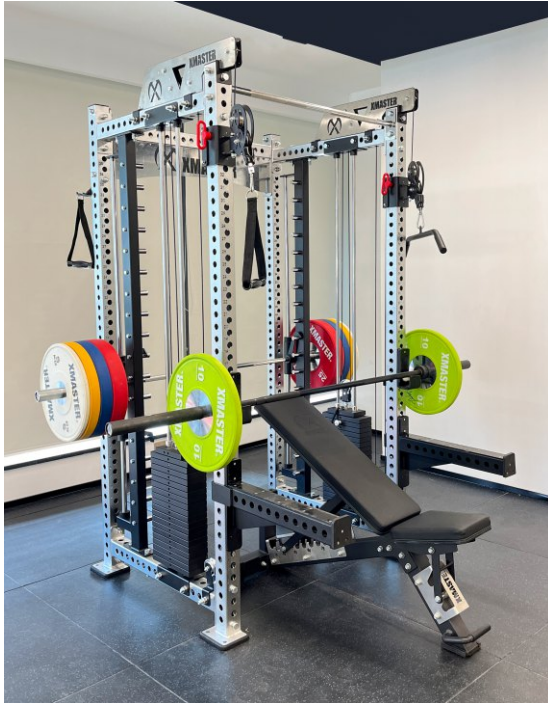

360 Power Landmine



Net weight: 4.8KG

Assembled Size: 400X73X105

Collar opening: 26mm

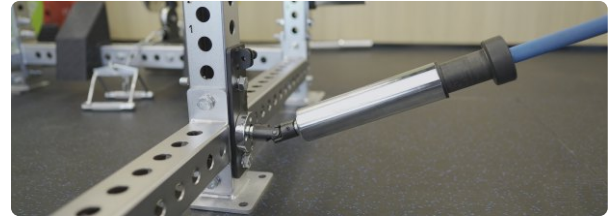

1. The 360 flexible adjustable design for any workout to the outside of the rack's uprights .



2. Easy lock-in design for locked and release the barbells in attachment easily.



3. Chromed design for a attractive outlook and are compatible with XMASTER chromed racks or any barbell with standard 50mm sleeves.

Flat Bench



Size

Please Note: Each bench is slightly measurements error due to the manual measuring.

Net Weight : 19KGS



- 1.Designed with 50X75mmx2.0mm steel tube with Matte Black Coating.
- 2.One-piece welded base structure ensures secure stability
- 3.High Density upholstery with anti-slip leather ensures comfortable using experience.
- 4.Easy to move with ergonomic and comfortable front handle with removable rear wheels.
- 5.Durable end cap prevents sliding and protects flooring.
- 6.Weight capacity: 450KGS.



Adjustable Bench



1. Designed with 75X75mmx2.0mm steel tube with Matte Black Coating.
2. Stainless Lock-in mechanism brings easy and secure angle adjustment.
3. 10 incline positions (0 to 85 degrees) and 3 seat positions (0, 15, and 30 degrees).
4. High Density upholstery with anti-slip leather ensures comfortable using experience.
5. Easy to move with ergonomic and comfortable front handle with removable rear wheels.
6. Weight capacity: 450KGS.

Size

Please Note: Each bench is slightly measurements error due to the manual measuring.

Net Weight : 44KGS

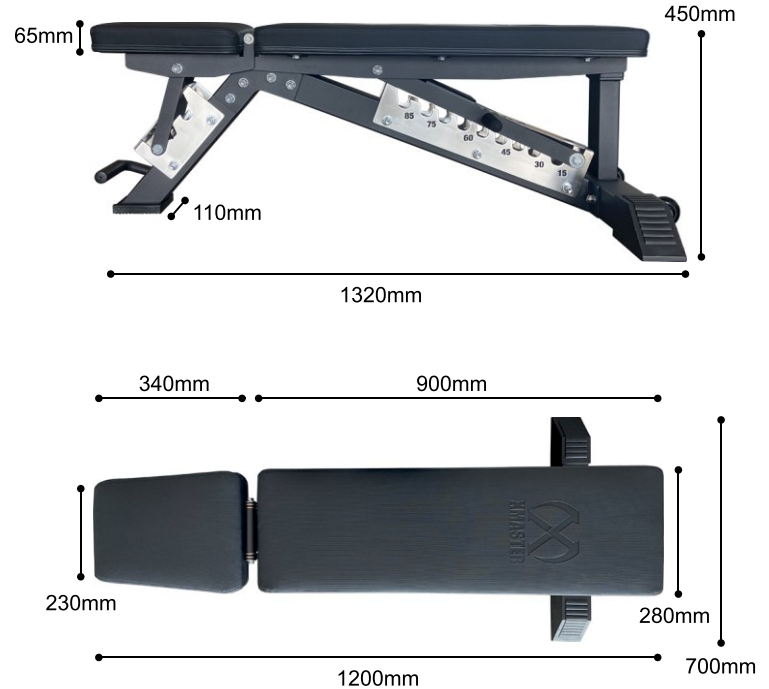

Adjustable Bench Pro



1. Designed with 100X20mmx2.5mm steel tube with Matte Black Coating.
2. Stainless Lock-in mechanism brings easy and secure angle adjustment.
3. 18 incline positions (-15 to 85 degrees) and 3 seat positions (0, 15, and 30 degrees).
4. High Density upholstery with anti-slip leather ensures comfortable using experience.
5. Easy to move with ergonomic and comfortable front handle with removable rear wheels.
6. Weight capacity: 500KGS.

Size

Please Note: Each bench is slightly measurements error due to the manual measuring.

Net Weight : 50KGS

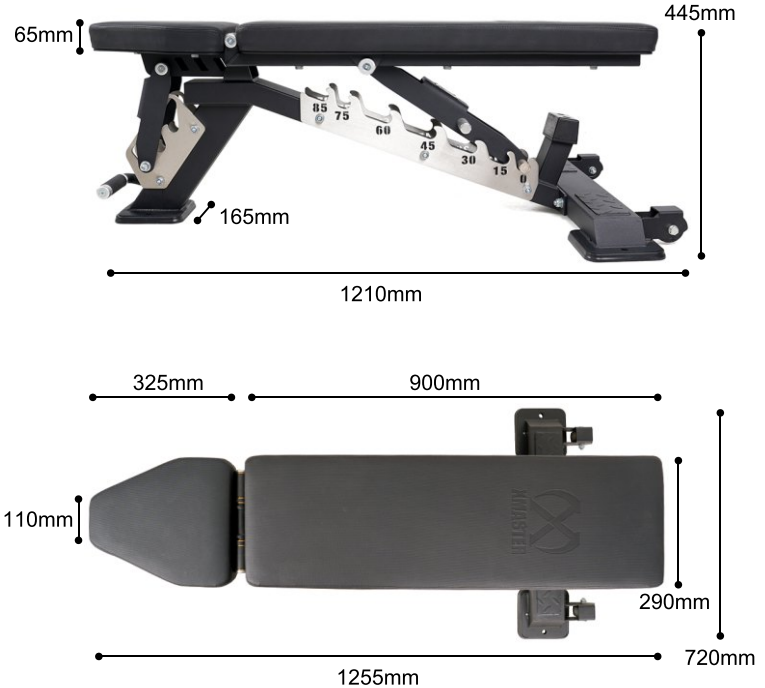

Dumbbell Rack



Net Weight: 60KG~200KG
Assembling Size: Vary with different storage ability
Material: Quality Steel
Surface Finish: Chrome Coating
Steel Thickness: 10mm



1. Quality Steel / Easy assembling / Secure Weight Capacity / Secure Stability



2. This rack available in two tiers and various dumbbell storage ability, store up to 5 pairs ~ 20 pairs.



3. The construction of the dumbbell racks allows to be assembled together to meet the needs of larger facilities.

Fixed Weight barbell Rack

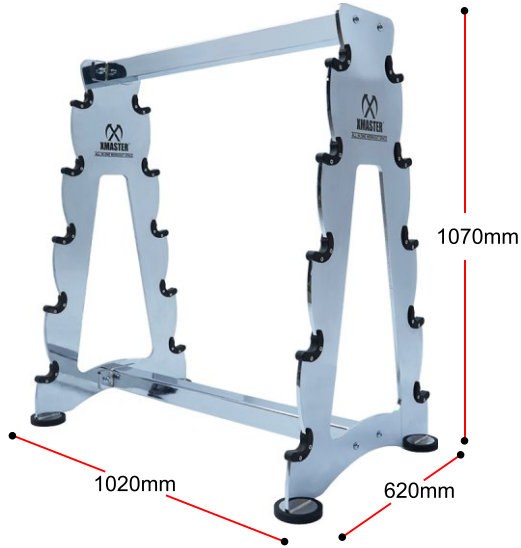

Net Weight: 58KG
Assembling Size: 1020mmx620mmx1070mm
Material: Quality Steel
Surface Finish: Chrome Coating
Steel Thickness: 10mm



1. Quality Steel / Easy assembling / Secure Weight Capacity / Secure Stability



2. The angled shelves designed with rubber coated supporter to prevent the dumbbells from sliding.



3. Two sides design with 10 piece of storage ability at the same time. Special construction design with chrome coating creating an exquisite appearance.

Vertical Plate Tree



Net Weight: 50KG
Assembling Size: 680X590X1600mm (L*W*H)
Steel Size: 75X75X3mm
Length of Storage Pin: 180mm
Spaced at each Storage Pin: 500mm

Size

Please Note: Each bench is slightly measurements error due to the manual measuring.

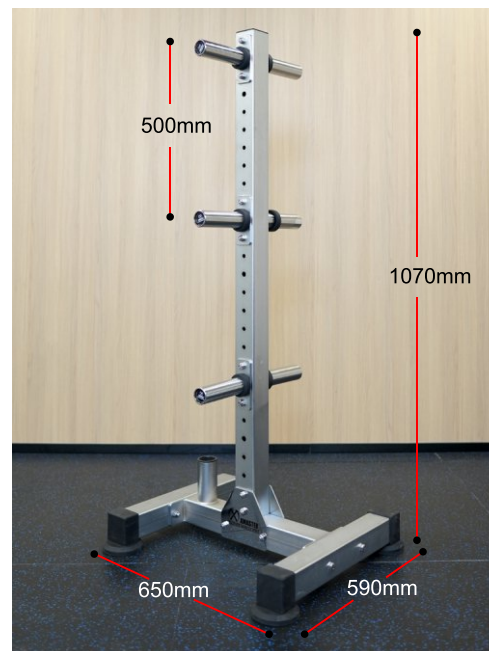

1. Durable non-slip rubber feet for extra stability and protect the floor.
2. Bolt-together design for the efficient assemble and it can reduce the shipping costs.

Fast -Lock Collars (Pair)



Size: 0.24KG/Pair

Thickness: 32mm

Material: Quality Nylon material

Diameter: 80mm

Collar Opening: 50mm



1. Quality Nylon material and rubberized interior lining.



2. Durable , non-slip for a steady hold on standard 50mm barbell.



3. Secure hold capability through repeated drops, quick release design.

Aluminum Collar (Pair)



Size: 0.32KG/Pair

Thickness: 33mm

Material: Aluminum construction

Diameter: 70mm

Collar Opening: 50mm



1. Aluminum construction and rubberized interior lining.



2. Durable, non-slip for a steady hold on standard 50mm barbell.



3. Secure hold capability through repeated drops, quick release design.

2.5KG Competition Steel Collar (Pair)



Size: 5KG/Pair
Thickness: 93mm
Material: Steel
Diameter: 102mm
Collar Opening: 50.2mm



1. Excellent chrome coating, high rust prevention capability.



2. Accurate weight tolerance for competition use.



3. Secure hold capability through repeated drops.

2.5KG Groove Sleeve Steel Collar (Pair)



steel debossed logo and weight number for custom brands

Size: 5KG/Pair
Thickness: 71mm
Material: Steel
Diameter: 135mm
Collar Opening: 50.2mm



1. Excellent chrome coating, high rust prevention capability.



2. Accurate weight tolerance for competition use.



3. Secure hold capability through repeated drops.

Natural Latex Rubber Stretch Bands



Material: Natural Latex Rubber
Length: 2080mm
Width: 13mm /22mm/32mm/45mm
Thickness: 4.5mm
Resistance: 5-50/10-60/25-80/50-120LBS
Color: changed on the resistance level



1. Made of environmental-friendly natural latex rubber.



2. Different resistance levels for a wide variety of training, such as the pull-up assistance, bench presses and joint-distraction etc.



3. Light weight, easy to take out for workout anywhere.

Chrome Steel Clubbell



Material: Steel

Finish: Chromed coating

Weight range: 4KG /6KG /8KG /10KG /12KG /16KG

/18KG /20KG

Weight tolerance : $\pm 1\%$

Diameter & Height : Vary from size



Heavy Mug



Material: 304 Stainless Steel
Product Size: 151x98x145mm
Net Weight : 8KG
Weight Tolerance : $\pm 1\%$

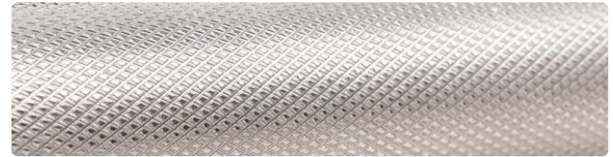

Anti-slip knurling handle with comfortable grip



Urethane Competition Kettlebell



Size: 4KG /6KG /8KG /12KG /16KG/
20KG /24KG /28KG /32KG

Width: 210, Height: 295mm

Color: Pink /Blue /Yellow /Purple /Green /orange /Red

Diameter of Handle: 34mm

Weight Tolerance: $\pm 1\%$



1. Good abrasion resistance, more crash resistant capability, environmental-friendly CPU.



2. Solid handle bar with quality chrome, firm touch feel, non-slip.



3. Durable CPU coating around the entirety of the kettlebell to prevent the scuffs.

Medicine Ball



Weight range: 6 /10 /14 /20 /25 /30LB

Diameter: 340mm

Material: 1000D PVC+PP cotton+ Iron Sand

Weight tolerance: $\pm 1\%$



1. Precision PVC leather coated construction with double stitched seam technology.



2. The interior flexible filling help to keep the ball shape across long time use and it is safe for high-speed, and high-intensity training.



3. Scuff-resistant material for a long lasting use on various training applications.

AB MAT



Size: 750X310X80MM

Material: Leather+ EPE

Weight: 0.95KG \pm 1%

Usage: core training accessory



1. Light weight with adjustable design for efficiently abdominal workout in anywhere.



2. Well selected leather coverage which is easy for cleaning after used in home gyms and commercial gyms.



3. Soft but with integrity firm foam inside which ensure the comfortable training use.

Ring



Specification : 2.8M/5M
Material: solid birch
Color : Wooden
Interior diameter: 173mm
Outer diameter: 236mm
Handgrip diameter: 32mm



1. Made of solid birch, anti-slip absorbent surface for safety gymnastic strength training.



2. High load-bearing sturdy carabiner and reinforced scuff-resistant ring straps in the safe using.



3. Easy to adjust the ring straps for different gymnastic training height.

Wooden Plyometric Boxes

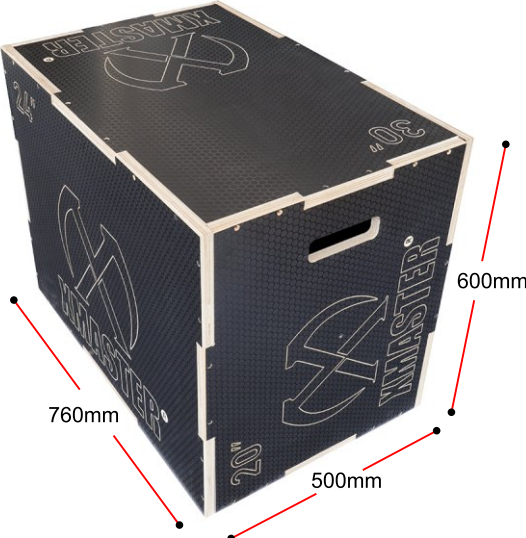

Size: 760X500X600MM
Wooden Thickness: 18.5mm
Net Weight: 24.1KG
Loading Bearing : 180KG



1. high density plywood material which is not easy to be distorted.



2. Reinforced inside construction for safe and effective plyometric training.



3. Scratch-resistant and anti-slip honeycomb coverage bring a cool outlook.

Foam Plyo Boxes

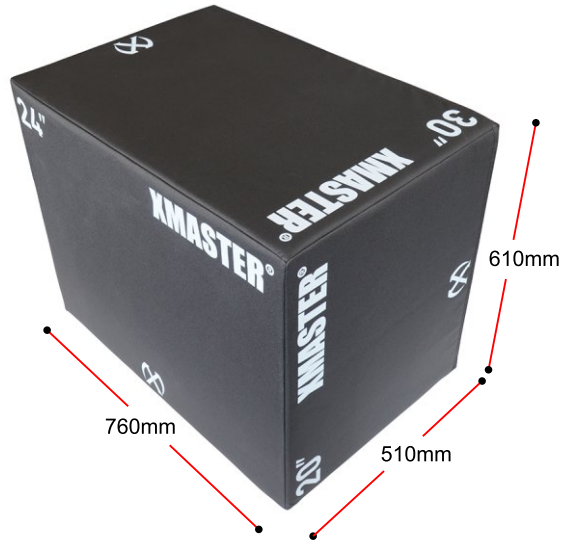

Size: 760X510X610mm
Material: EVA
Net Weight: 23.1KG
Loading bearing: 180KG



1. Precision EVA coated construction with custom brand on six sides.



2. High density protective padding inside and soft foam on all sides bring a secure training feelings.



3. Scratch-resistant and water-proof coverage supplying a anti-slip function at the same time.

Crash Cushion

Size

Please Note: Each bench is slightly measurements error due to the manual measuring.



Net Weight: 25kg per pair
Product Size: 750x600x150 MM
Material: High Density upholstery
Sponge Density: 150KG/M³
Function: Sound attenuation and protects flooring



High Density upholstery designed to lower the bounce and protect the trainer

Wrist Wraps



Product Name	Color	Size	Thickness	Width
Standard Model	Green	40/60/100mm	0.3cm	8cm
Thick Model	Red	40/60/100mm	0.5cm	8cm

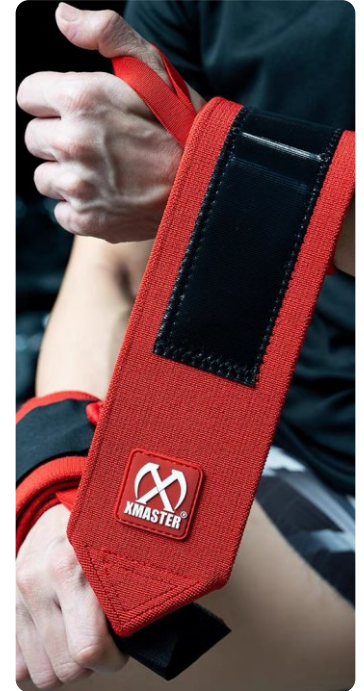

1. widen thumb loop for more comfortable use .
- 2.High density polyester cotton material help to greater wrist stability during workout.
- 3.Velcro design for easy adjustments, and quick removal.

Knee Sleeve



Color: Black / Red

Size: S / M / L / XL / XXL / XXXL

Thickness: 7mm

Material: Nylon, Elastic Fiber



1. 7MM thick material construction for firm and comfortable support.
2. The flexible compression material help to reduce knee strain during and after workout.
3. Abrasion blend material is easy for cleaning.

Weightlifting Belt



Color: Black+Red / Blank+Grey

Size: XS / S / M / L / XL

Thickness: 7mm

Material: Nylon + EVA + PVC

独特锥形设计



1.Durable adjustable velcro closure design which is quick and easy to fasten and release the belt. Providing the ideal amount of support for your specific training quickly.



2.Made of high-quality nylon that fit the contours of the body, give you the balance and stability of abdominal pressure, improve the core stability and protect the spine from injury.

13MM Powerlifting Belt



Color: Black+Red / Grey+ Apricot
Size: XS / S / M / L / XL
Thickness: 13mm
Width: 10Cm
Material: Zinc Alloy + Leather



1. Standard 13mm thick and 10 cm wide delivers a safety comfortable support during heavy lifting.



2. Mechanical Lock-in buckle design to maximize stability and adjustability . it can prevents any movements during training.



3. Durable leather belt with more adjustable holes gives the belt an exact and fully customized fit.

Speed Rope(Aluminium)



Material: Aluminum handle + Steel Bearing + Nylon coated braided steel cable.

Length: 3M

Weight: 0.16KG

Bearings: Two Hi-Precision ball bearings per rope

Diameter of coated cable: 2.5mm

Handle Length: 15.7CM

Color: Purple/Green/Blue/Grey or custom color options



1. Aluminium non-slip handle with medium knurled design for comfortable touching.



2. The smooth 360° bearing system allows an excellent revolutions speed and move rope in any direction.



3. Super Rotating handle grip design helps to break your records.

4. Swivel locking clips, easy to adjust the length of speed rope.

Speed Rope(Plastic)



1. Plastic non-slip handle for comfortable touching.



2. Swivel locking clips, easy to adjust the length of speed rope.



3. Adjustable end with two Hi-Precision deep groove ball bearings for move rope in any direction.



Material: Plastic handle + Plastic head + Nylon coated braided steel cable.

Rope Length: 3M

Weight: 0.1KG

Bearings: Two Hi-precision deep groove ball bearings

Diameter of coated cable: 2.5mm

Handle Length: 15.7CM

Color: Black/Green/Red and custom color optio

Rubber Floor



Size: 50x50x3CM

Material: Solid EPDM roll and recycled SBR granules

Color: Black +Blue/White/ Custom granulated color

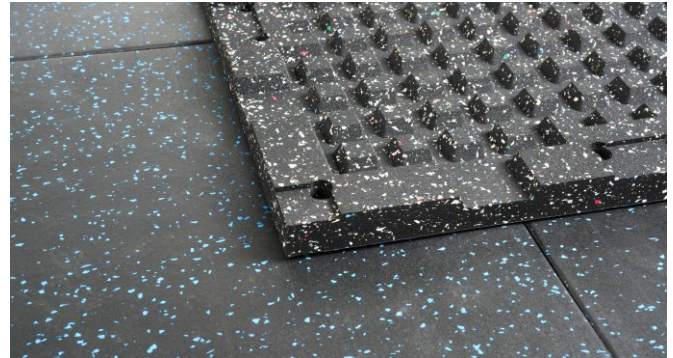
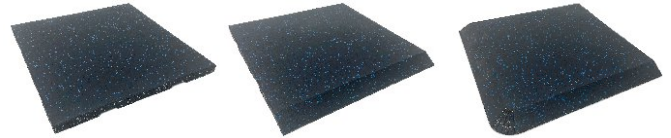

1. Well selected environmental raw material , small odour or odourless for using indoor.
2. Special molded bottom layer design for energy absorbing and sound absorbing.
3. Solid material improves floor durability for gym facility.
4. Custom colors available to match your facility colors.



Changtai Excellent Fitness Co.,Ltd

Phone: +86 15280242193

E-Mail: info@xmasterfitness.com

Add: Xintai Industrial Zone, Changtai County,
Zhangzhou City, Fujian Province, China